

Product Dimensions

Created by: luis.ramos@sersef.com

Created on: 12/03/2026

Designation

A 70 3 UH70 35.4 P160 B3 LO AR BP

Dimensions [mm], Italic [In]

Gearbox Dimensions

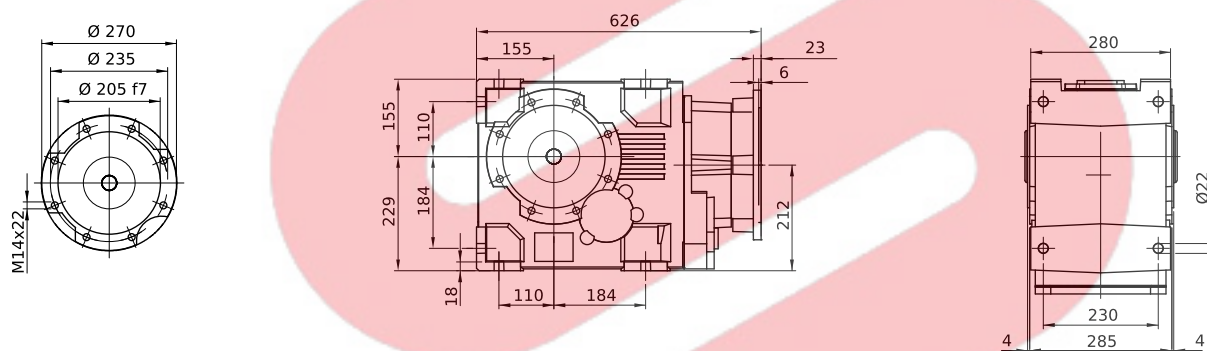

Input Dimensions

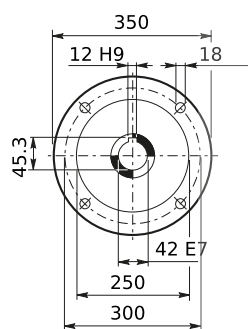

Output Shaft

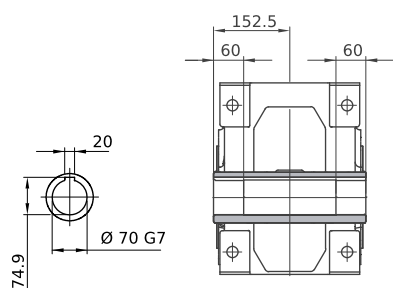

Mounting Position

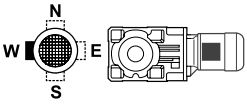
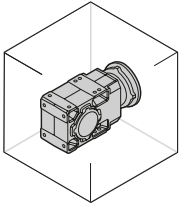

Customer's Shaft

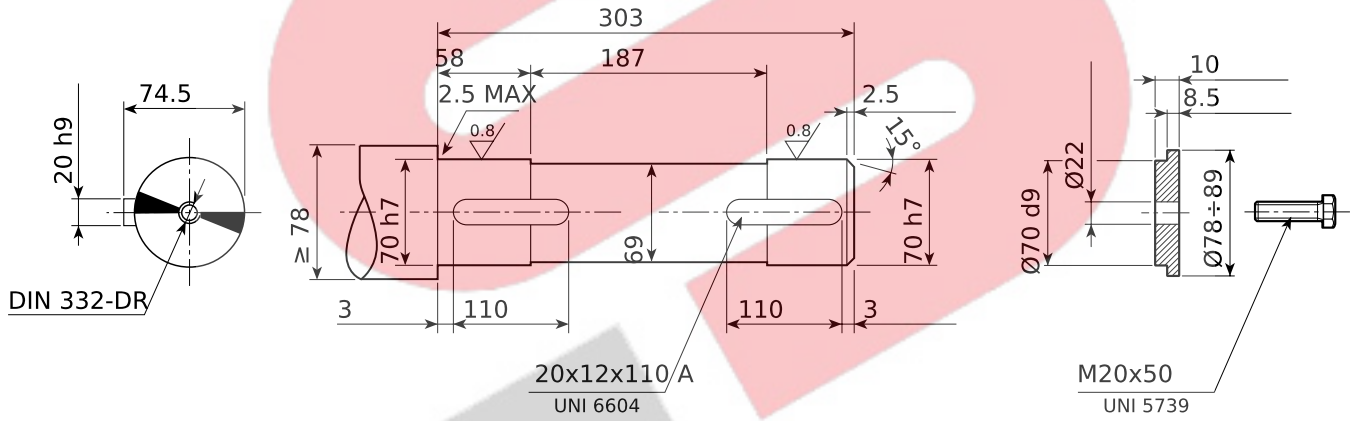

Anti Run-Back

